



HOPPERS

Wastequip hoppers were previously sold under the Galbreath brand, and still offer the same quality users have trusted for years.

SELF-DUMPING HOPPERS



Wastequip hoppers are great for storing, transporting and dumping scrap and bulk material. Self-dumping hoppers are designed for industrial, commercial and institutional applications, and are particularly useful for in-plant housekeeping, in-process material handling, sorting and storing, scrap collection, materials recycling and other rugged applications. Self-dumping hoppers allow for safe and easy loading, transporting and dumping of material. Wastequip hoppers are available in a variety of configurations to fit your application. They have standard red oxide primer finish or can be painted in a variety of colors.

FEATURES

Standard red oxide primer finish

Unique tapered press-fitted rocker pin that self-centers front and back and side to side when "rocked in"

Standard hopper lock **1**

Press-fitted locker pin **2**

Spring-loaded latch with reinforced latch pin

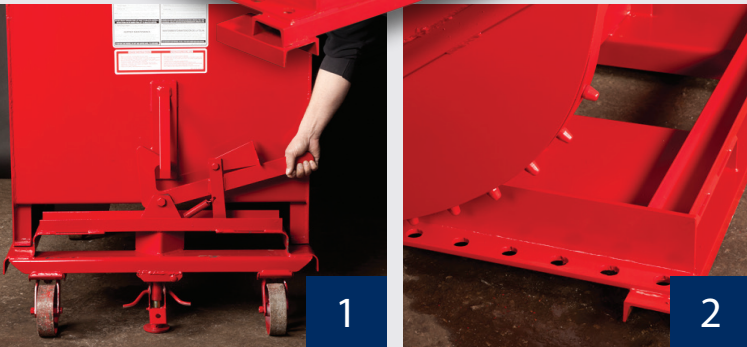

THE WASTEQUIP HOPPER PRODUCT OFFERING INCLUDES:



STANDARD-DUTY SELF-DUMPING HOPPERS
1/8 to 1-1/2 cubic yards



HEAVY-DUTY SELF-DUMPING HOPPERS
(LARGE CAPACITY)
1-1/2 to 5 cubic yard



HEAVY-DUTY SELF-DUMPING HOPPERS
(LOW PROFILE)
2-1/2 to 3-1/2 cubic yard



LIGHT-DUTY SELF-DUMPING HOPPERS
1/2 to 2-1/2 cubic yard



OPEN END SELF-DUMPING HOPPERS



DOCK CARTS



LIGHT-DUTY SELF DUMPING HOPPERS

1/2 TO 2-1/2 CUBIC YARDS

Wastequip light-duty self-dumping hoppers are ideal for lightweight materials or bulky materials that take up more space than weight. These hoppers are a great fit for lightweight recycling, plant maintenance, wood scraps of all types (sawdust, pallets, cabinets, paper mills), as well as cardboard, plastic and metal shavings. Hoppers are constructed of 12 gauge steel with fully welded rocker stop supports and formed base.

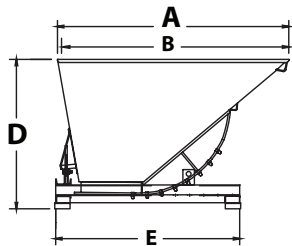

1/2, 1, 1-1/2 cubic yard hoppers

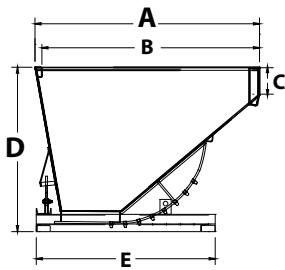

2, 2-1/2 cubic yard hoppers

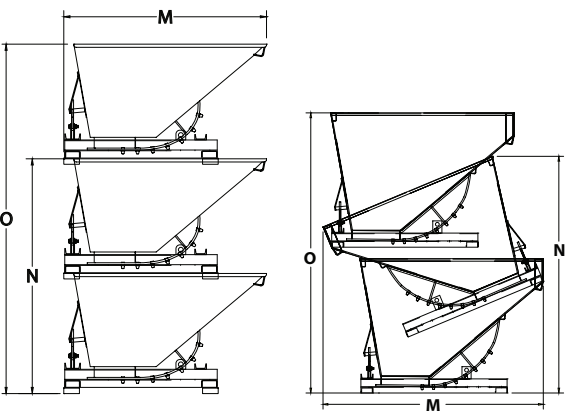
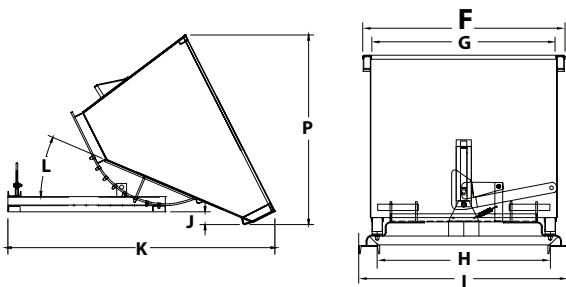

FEATURES

12 gauge steel body

1" round rocker stops

Designed for 1,500 to 2,000 lb. capacities

	LH-50	LH-100	LH-150	LH-200	LH-250
Vol. capacity (cu. yds.)	1/2	1	1-1/2	2	2-1/2
Weight capacity (lbs.)	1,500	1,500	2,000	2,000	2,000
Shipping weight (lbs.)	369	417	472	509	570
A- Outside Dimension	49-1/4"	60-1/2"	60-1/2"	60-1/2"	60-1/2"
B	47-1/2"	58-1/2"	58-1/2"	58-3/8"	58-3/8"
C	n/a	n/a	n/a	7-1/4"	7-1/4"
D-Outside Dimension	30-3/4"	39"	37-1/2"	44"	44"
E	39-1/4"	48"	48"	48"	48"
F-Outside Dimension	39-3/4"	39-3/4"	58-1/4"	58-1/4"	72-1/2"
G	36-1/2"	36-1/2"	54-3/4"	54-3/4"	54-3/4"
H	36-1/2"	38"	38"	38"	38"
I	40-1/2"	40-1/2"	38-5/8"	38-5/8"	38-5/8"
J	8-3/8"	3-1/2"	3-1/2"	3-7/8"	3-7/8"
K	59"	76"	76"	81-1/2"	81-1/2"
L	20°	21-1/2°	21-1/2°	23°	23°
M	55"	86"	67"	75"	75"
N	59-1/2"	77"	70"	78"	78"
O	89"	114"	77-1/2"	93-1/2"	93-1/2"
P	47"	54"	57"	58"	58"

NOTE: The LH-50 and LH-100 stack. The LH-150, LH-200 and LH-250 nest.



STANDARD-DUTY SELF DUMPING HOPPERS

1/8 TO 1-1/2 CUBIC YARDS

Wastequip standard-duty self-dumping hoppers are designed for forklift handling of materials, particularly for demanding applications such as commercial construction, machine shops, fabrication, in-process material handling, sorting and storing operations, materials recycling and scrap collection for metal, glass, stone and more. The 7 gauge steel body features a channel for additional support on the hopper body and an angle-reinforced formed steel base with 1" plate rocker stops. Rocker allows hopper to roll forward and backward for easier dumping with the pull of a handle. Rocker stops lock the hopper in place for safety.

FEATURES

- Durable 7 gauge steel body
- 1" round rocker stops
- Designed for 1,500 to 6,000 lb. capacities

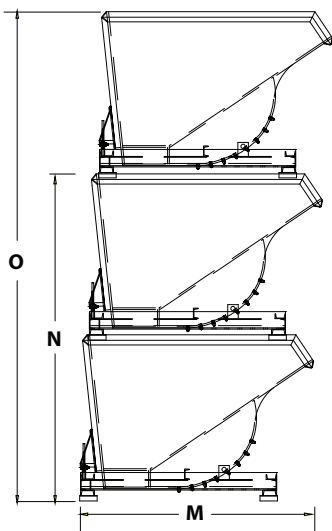
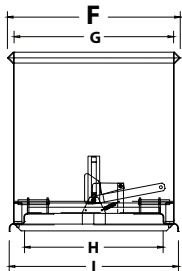
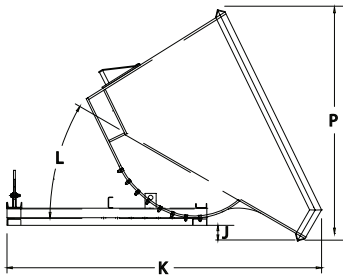
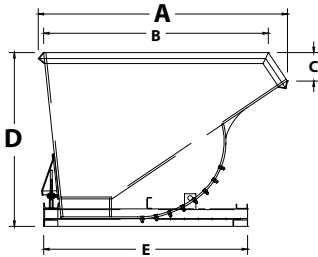

	H-125	H-25	H-375	H-50N	H-50	H-75	H-100	H-150
Vol. capacity (cu. yds.)	1/8	1/4	3/8	1/2	1/2	3/4	1	1-1/2
Weight capacity (lbs.)	1,500	3,000	3,000	4,000	4,000	5,000	6,000	6,000
Shipping weight (lbs.)	254	400	420	420	460	580	600	750
A- Outside Dimension	31"	46-3/8"	47"	49-1/4"	47-3/16"	59"	62-1/8"	66"
B	30-1/2"	45-3/4"	44"	46-1/4"	44"	55-1/2"	58"	59-3/4"
C	0	0	2-1/2"	5-1/4"	2-1/2"	3"	4"	8"
D-Outside Dimension	17-1/2"	26-1/2"	31"	35-1/2"	31"	36"	38"	46"
E	29"	42-1/2"	42-1/2"	42-1/2"	42-1/2"	48"	48"	54-1/2"
F-Outside Dimension	31"	30-1/8"	32-1/4"	32-1/4"	39"	39"	39-1/2"	44-1/2"
G	30"	29"	29"	29"	36"	36"	36"	41"
H	25"	23-1/2"	23-1/2"	23-1/2"	30-1/4"	30-1/4"	30-1/4"	35-1/2"
I	31"	31-3/4"	31-1/2"	31-1/2"	39"	39"	39"	43-1/2"
J	4-1/2"	7"	6"	8"	7"	11"	9"	6"
K	39"	56-1/2"	60"	65"	60"	71"	75"	85"
L	45°	45°	42°	42°	42°	33°	31°	30°
M	n/a	52"	54"	61"	58"	65"	68"	73"
N	n/a	51-1/2"	60-3/4"	69-1/2"	61-1/2"	72-3/4"	75-1/4"	91-1/2"
O	n/a	76-1/2"	90-1/2"	103-1/2"	91-1/2"	108-1/2"	112-1/4"	136-1/2"
P	29-1/2"	45"	46"	49"	46"	57"	58"	63"



HEAVY-DUTY SELF DUMPING HOPPERS (LARGE CAPACITY)

1-1/2 TO 5 CUBIC YARDS

Wastequip heavy-duty self-dumping, large capacity hoppers are designed for "shock" loads or conveyor feed applications for foundries, scrap haulers and similar applications that require a structural base. They feature a 7 gauge steel body with angle reinforcements and structural steel base.

FEATURES

- Heavy-duty 7 gauge steel body
- 1" round rocker stops on 1-1/2, 2, 2-1/2 yd. models
- 1/4" round rocker stops on 3, 4 and 5 yd. models
- Designed for 4,000 to 6,000 lb. capacities

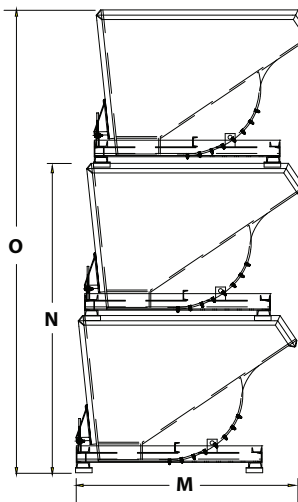
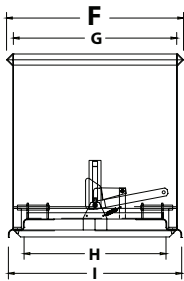
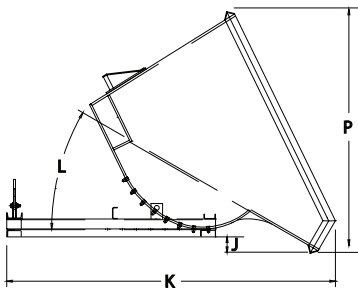
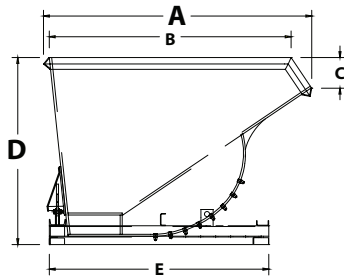

	H-150W	H-200	H-250	H-300	H-400	H-500
Vol. capacity (cu. yds.)	1-1/2	2	2-1/2	3	4	5
Weight capacity (lbs.)	6,000	6,000	6,000	5,000	4,000	4,000
Shipping weight (lbs.)	790	920	950	1,250	1,430	1,570
A- Outside Dimension	62"	66"	67"	73-3/8"	73-3/8"	73-3/8"
B	58"	59-1/2"	56"	63"	63"	63"
C	3-7/8"	8"	15"	11-1/2"	11-1/2"	11-1/2"
D-Outside Dimension	39-3/8"	48"	55"	58-1/2"	58-1/2"	58-1/2"
E	48-1/2"	56-1/2"	56-1/2"	59"	59"	59"
F-Outside Dimension	57-1/2"	57"	57-9/16"	63-7/8"	83-7/8"	103-7/8"
G	54"	54"	54"	60"	80"	100"
H	32"	32"	32"	32"	32"	32"
I	58"	58"	58"	57"	57"	57"
J	8"	5"	4"	1/2"	1/2"	1/2"
K	75"	87"	93"	98"	98"	98"
L	30°	30°	30°	23°	23°	23°
M	74"	78"	79"	n/a	n/a	n/a
N	78-3/4"	94-3/4"	108-3/4"	n/a	n/a	n/a
O	117-1/2"	141-1/2"	162-1/2"	n/a	n/a	n/a
P	59"	65"	68"	60"	60"	60"



HEAVY-DUTY SELF DUMPING HOPPERS (LOW PROFILE)

2-1/2 TO 3-1/2 CUBIC YARDS

Wastequip heavy-duty self-dumping hoppers with low profile design offer the advantage of increased capacity for equipment that requires a lower height requirement. Units incorporate a new heavy-duty base for forklift handling of materials, in-plant house-keeping, scrap collection and more. These hoppers feature a 7 gauge body with angle reinforcement and 1" round rocker stops.

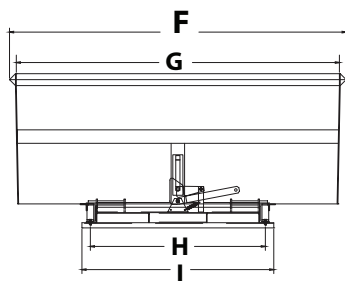
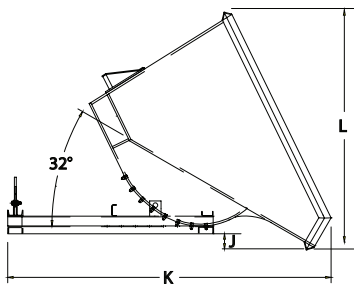
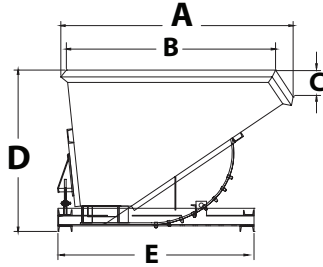

FEATURES

- Heavy-duty 7 gauge steel body
- 1" round rocker stops
- Designed for 5,000 to 6,000 lb. capacities

	H-250LP	H-300LP	H-350LP
Vol. capacity (cu. yds.)	2-1/2	3	3-1/2
Weight capacity (lbs.)	6,000	5,000	5,000
Shipping weight (lbs.)	1,151	1,304	1,416
A- Outside Dimension	66-1/2"	66-1/4"	66"
B	59-1/2"	59-1/2"	59-1/2"
C	7-1/2"	7-1/2"	7-1/2"
D-Outside Dimension	46"	46"	46"
E	56-1/2"	56-1/2"	56-1/2"
F-Outside Dimension	66"	85-1/2"	99-1/2"
G	62"	82"	96"
H	47-3/4"	47-3/4"	47-3/4"
I	57"	57"	57"
J	5"	5"	5"
K	87"	87"	87"
L	30"	30"	30"

OPEN-END SELF-DUMPING HOPPERS



FEATURES

- Heavy-duty 7 gauge formed channel frame and formed steel base
- 1" round rocker stops
- Designed for 360 to 690 lb. capacities

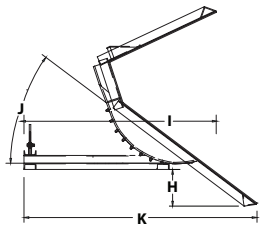
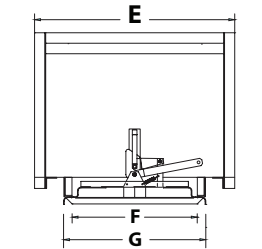
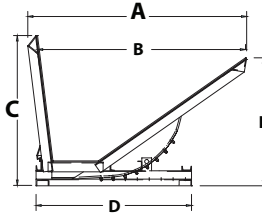

	HOE-1	HOE-2
Shipping weight (lbs.)	360	690
A- Outside Dimension	47-1/2"	67-1/2"
B	45"	64-1/2"
C-Outside Dimension	30"	46-3/4"
D	42-1/2"	48-1/8"
E-Outside Dimension	42" (min)	54" (min)
F	30-1/2"	30-1/2"
G	38"	38-1/2"
H	6-5/8"	12-1/2"
I	49"	63-1/4"
J	42°	37°
K	57"	77"
L	28"	39-1/4"

DOCK CARTS



FEATURES

- 14 gauge steel body
- Designed for 1,600 lb. capacities

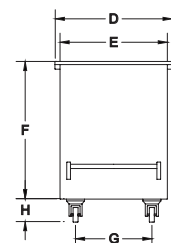
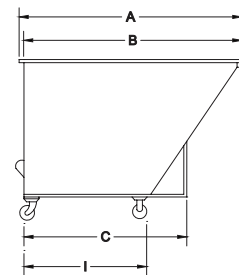

Wastequip dock carts are designed for manual handling of paper, wood and other lightweight, in-plant materials. The carts feature a 14 gauge steel body. Casters include two rigid and two swivel casters along with 6" x 2" rubber mold-on casters.

	DC-100	DC-150	DC-200
Vol. capacity (cu. yds.)	1	1-1/2	2
Weight capacity (lbs.)	1,600	1,600	1,600
Shipping weight (lbs.)	215	253	287
A	59"	59"	59"
B	57"	57"	57"
C	41"	41"	41"
D	30-1/2"	44-5/8"	57-5/8"
E	27"	41"	54"
F	35-1/2"	35-1/2"	35-1/2"
G	21"	35"	48"
H	7-1/2"	7-1/2"	7-1/2"
I	33"	33"	33"

HOPPER OPTIONS

CASTERS

Semi-steel, phenolic, rubber mold-on or polyurethane (two swivel and two rigid) casters available.



Semi-steel



Phenolic



Rubber Mold-on



Polyurethane

OPTION	TYPE	CAPACITY	WHEEL	BEARING	HEIGHT	WEIGHT
NO. 1	4" Semi-Steel	3200 lbs.	4"x1-1/2"	Roller	5-3/4"	28 lbs.
NO. 2	6" Semi-Steel	3400 lbs.	6"x2"	Roller	7-1/2"	46 lbs.
NO. 3	8" Semi-Steel	4200 lbs.	8"x2"	Roller	10"	64 lbs.
NO. 4	6" Phenolic	3600 lbs.	6"x2"	Self Lubricating	7-1/2"	44 lbs.
NO. 5	6" Rubber- Mold-On	1640 lbs.	6"x2"	Roller	7-1/2"	42 lbs.
NO. 6	8" Rubber- Mold-On	2000 lbs.	8"x2"	Roller	10"	60 lbs.
NO. 7A	6" Polyurethane	3600 lbs.	6"x2"	Roller	7-1/4"	36 lbs.
NO. 7B	8" Polyurethane	3600 lbs.	8"x2"	Roller	9-1/2"	38 lbs.

Castors not available for models H-300, H-300LP, H350LP, H400 or H500.

HOPPER COVERS

Hopper covers offer debris containment and security. Constructed of carbon steel, these covers feature an X-crimp design for water drainage.

OPTION	HOPPER SIZE	TYPE A	TYPE B	TYPE C
NO. 16	1/2 yd.	50 lbs.	56 lbs.	54 lbs.
NO. 17	3/4 and 1 yd.	59 lbs.	64 lbs.	62 lbs.
NO. 18	1-1/2 yd.	80 lbs.	86 lbs.	85 lbs.
NO. 19	2 yd.	102 lbs.	110 lbs.	108 lbs.
NO. 20	2-1/2 yd.	109 lbs.	117 lbs.	114 lbs.

Covers are a non-inventory item. Please allow additional time for manufacturing.

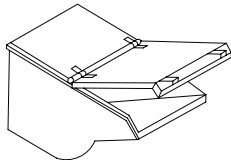

TYPE A
Weld on back with single center hinge

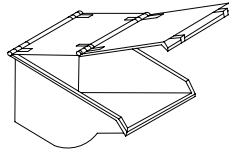

TYPE B
Double hinged – Back and center

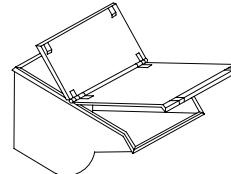

TYPE C
Single hinged center

OPTIONS

- Hopper retaining chain and bracket **1**
- Hopper floor lock **2**
- Three-way entry (1/4 to 3 cubic yard sizes only) **3**
- Platform legs **4**
- Pull bracket with 10' nylon rope **5**
- Drain plug
- Drain sump
- Crane pick-up eyes
- Available in multiple paint options

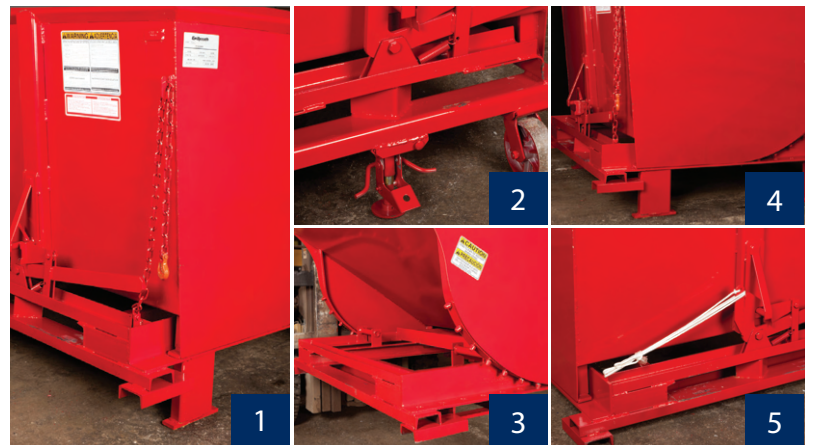

Standard Color Choices*



Colors shown are as accurate as printing allows. The actual color is subject to variation from the printed color sample. Color choices vary by plant location. Please contact your local sales representative for available colors. Custom colors are available upon request and are subject to an additional charge.



Tel: 877.468.9278 | sales@wastequip.com | www.wastequip.com

Wastequip reserves the right to make changes to designs, specifications, and components at any time without notice. Information contained within this literature is intended to be the most accurate available at time of printing. For our terms and conditions of sale, including our limited warranty, please visit www.wastequip.com.

©2023 Wastequip, LLC. All rights reserved.

WQP099-052023